

NANDO sospensione

Luca De Bona e Dario De Meo design

anno 2015

SCHEDA TECNICA - SE109 10 INT

CORPO LAMPADA "A"

materiale metallo
colore oro



ROSONE "E"

materiale metallo
colore nero opaco

CAVO ELETTRICO "C"

materiale telaio
colore nero



DISPOSITIVO ELETTRICO

portalampane E27
sorgente luminosa max 1x77w
classe energetica da E a A++





PACKAGING

n° colli 1
peso netto/kg 1,7
peso lordo/kg 2
imballo/cm 32x25x32

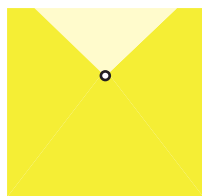
EMISSIONE LUMINOSA

unidirezionale



 diretta
 filtrata
 indiretta
 assenza

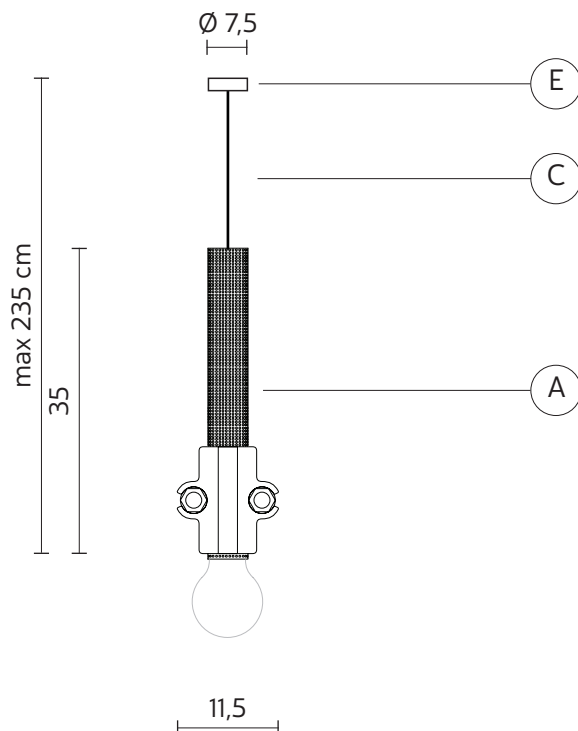

CERTIFICAZIONI

IEC 60598-1:2008
EN 60598-1:2008 + A11:2009



grado di protezione lampadina IP20
opzionale



articolo **700L**
filamenti di tungsteno
E27 - 25w - ≤ 60 lumen
classe E

COLLEZIONE

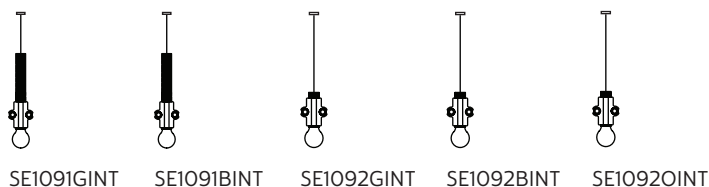

Le lampadine fornite sono solo ed esclusivamente decorative e non di illuminazione.