

SETTENANI COLLECTION - "EOLO" sospensione

Matteo Ugolini design

anno 2014

SCHEDA TECNICA - SE681N1

CORPO LAMPADA "A"

materiale	ceramica	
colore	bianco	

ROSONE "E"

materiale	metallo
colore	grigio opaco

CAVO ELETTRICO "C"

materiale	PVC	
colore	trasparente	

DISPOSITIVO ELETTRICO

portalampade	E27
sorgente luminosa	max 1x70w
classe energetica	da E a A++





PACKAGING

n° colli	1
peso netto/kg	4,15
peso lordo/kg	5,4
imballo/cm	35x35x38

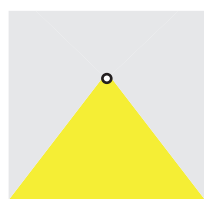
EMISSIONE LUMINOSA

unidirezionale



	diretta
	filtrata
	indiretta
	assenza

CERTIFICAZIONI

IEC	60598-1:2008
EN	60598-1:2008 + A11:2009



grado di protezione lampadina	IP20 non inclusa
-------------------------------	---------------------

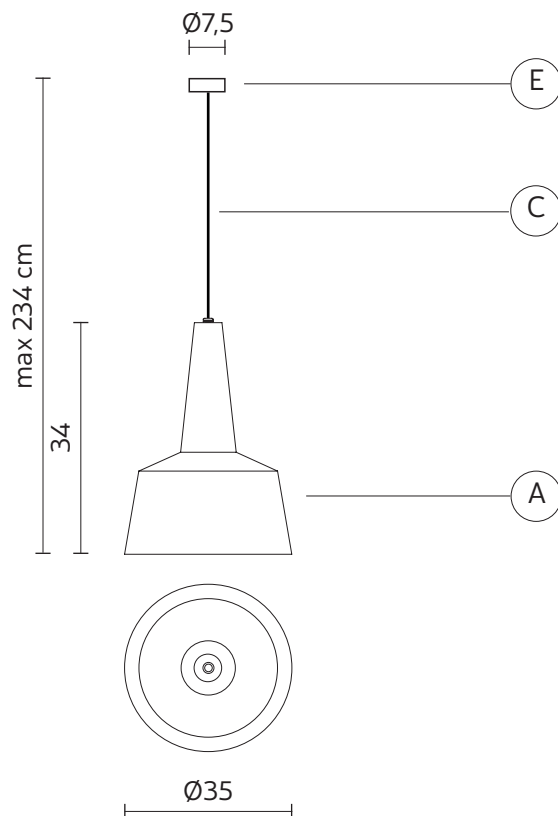

COLLEZIONE

disponibili anche nella versione da tavolo e piantana

