

AMARCORD lampada da tavolo

Matteo Ugolini design

anno 2018

SCHEDA TECNICA - CT121 BS INT

BASE "A"

materiale
cemento
colore
bianco



DIFFUSORE "B"

materiale
vetro
colore
trasparente
satinato*



CAVO ELETTRICO

colore
trasparente



DISPOSITIVO ELETTRICO

portalampane
E27
sorgente luminosa
1 x max 52W
classe energetica
da E a A++





PACKAGING

n° colli
2
peso netto/kg
1,9 (A+B)
peso lordo/kg
2,2 (A+B)
imballo/cm
21x21x20(A) - 24x24x39(B)

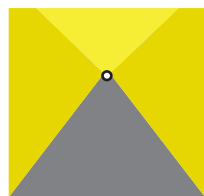
EMISSIONE LUMINOSA

unidirezionale



 diretta
 filtrata
 indiretta
 assenza

CONFORME ALLE

IEC
EN
60598-1:2014
60598-1:2015



grado di protezione
lampadina
IP20
opzionale



articolo **700P***
filamenti di tungsteno
E27 - 25/40W ≤60lumen
classe E

***le lampadine fornite sono solo ed esclusivamente decorative e non di illuminazione**

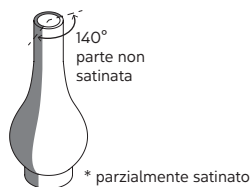
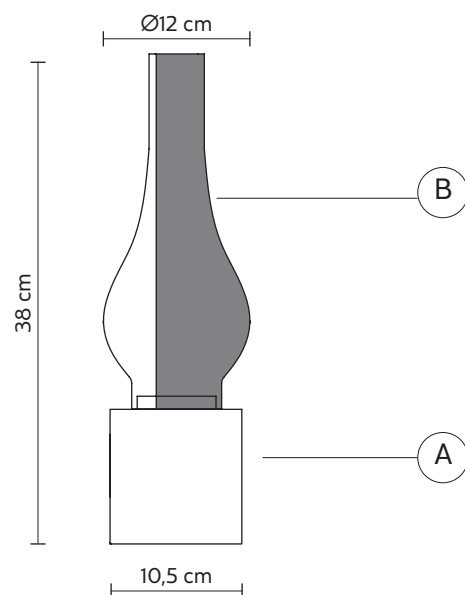

COLLEZIONE

disponibile anche nella versione applique



CT121 1B INT



CT121 BF INT



CT121 GT INT



CT121 1G INT



CT121 GS INT