

Cluster

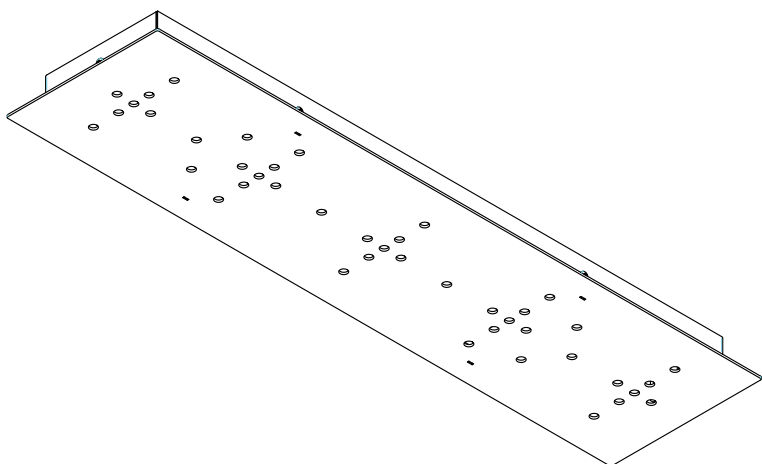

SR090CB INT - MAX 19 Pendant

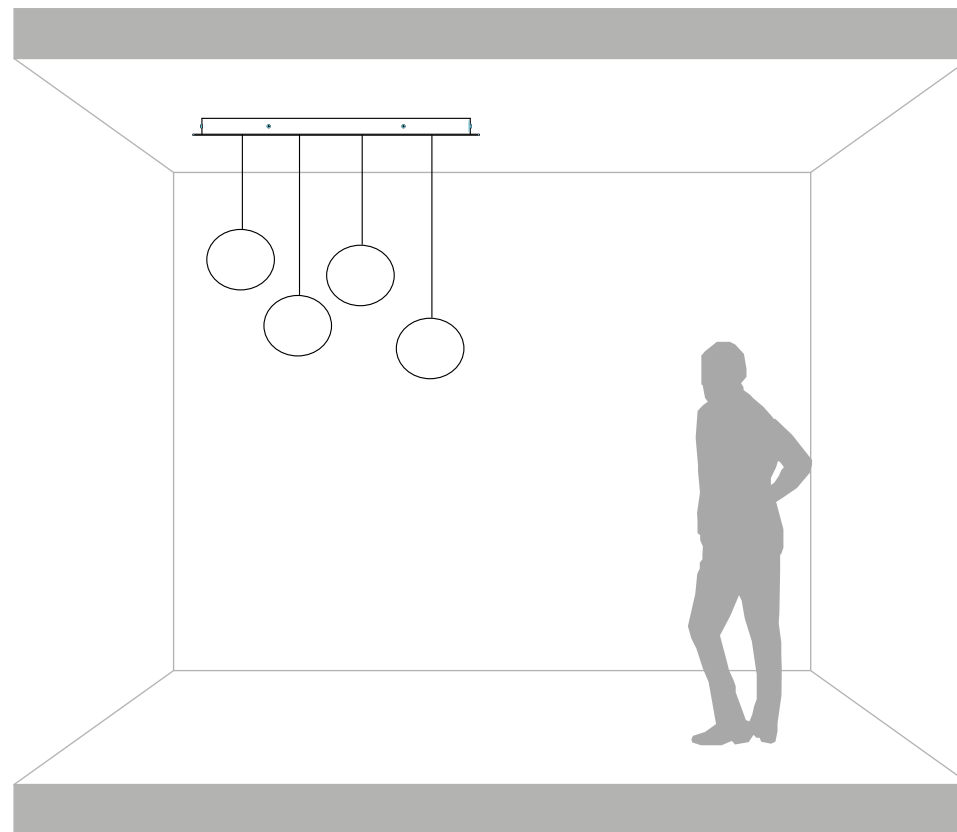

Karman srl

Via A. Grandi, San Martino del piano, 61034 Fossombrone (PU), Italy
p.iva 02175640412 tel +39 0721 71 5042 r.a fax +39 0721 716640 - www.karmanitalia.it

KARMAN

SR090CB INT - (b) MAX80 Kg



C - 01

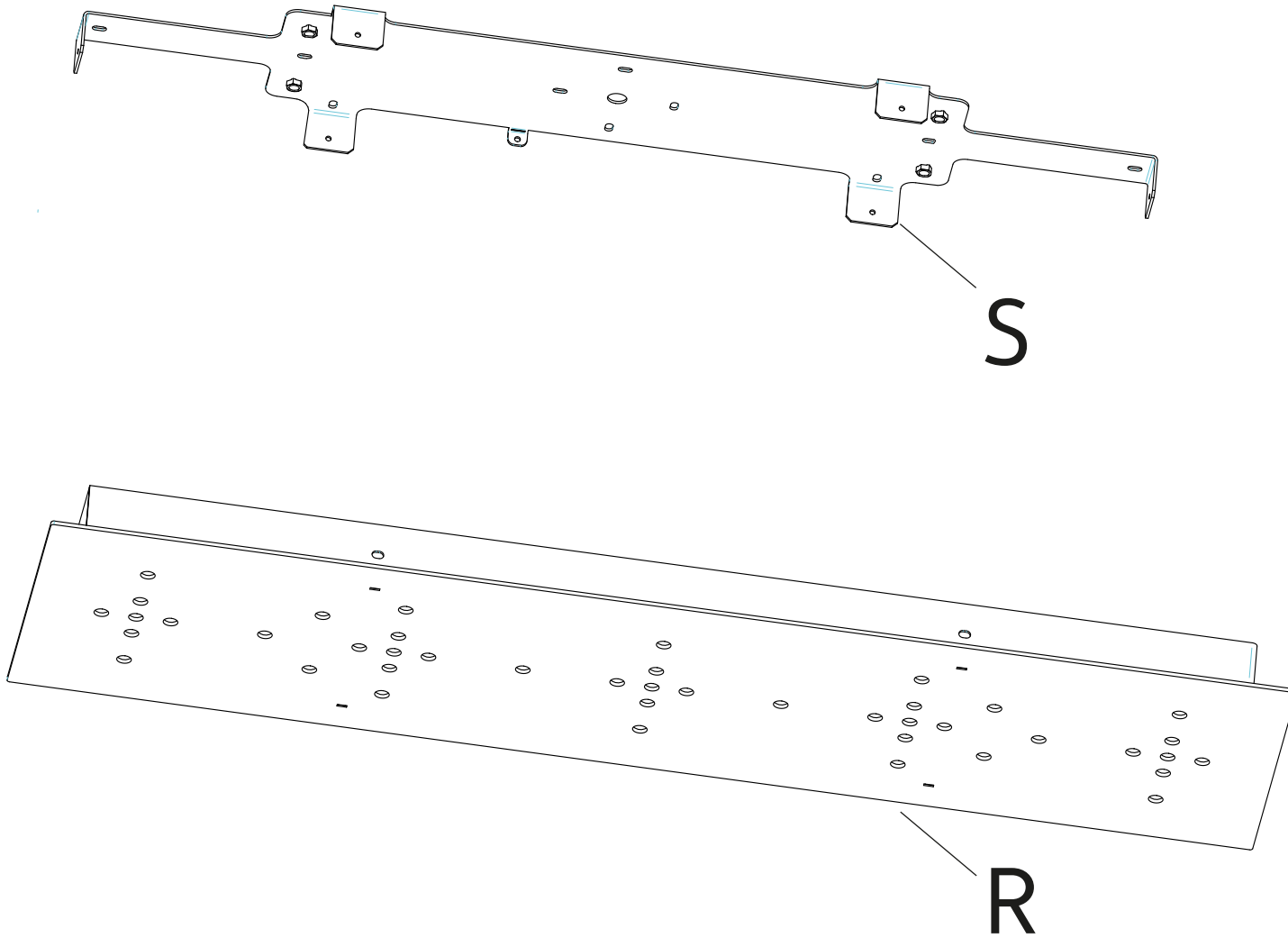

T

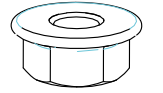

x4

O

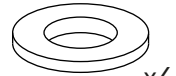

x4

P

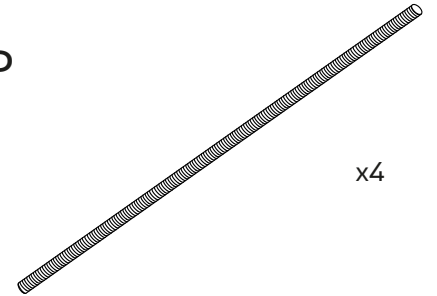

x4

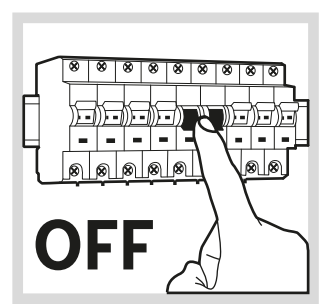
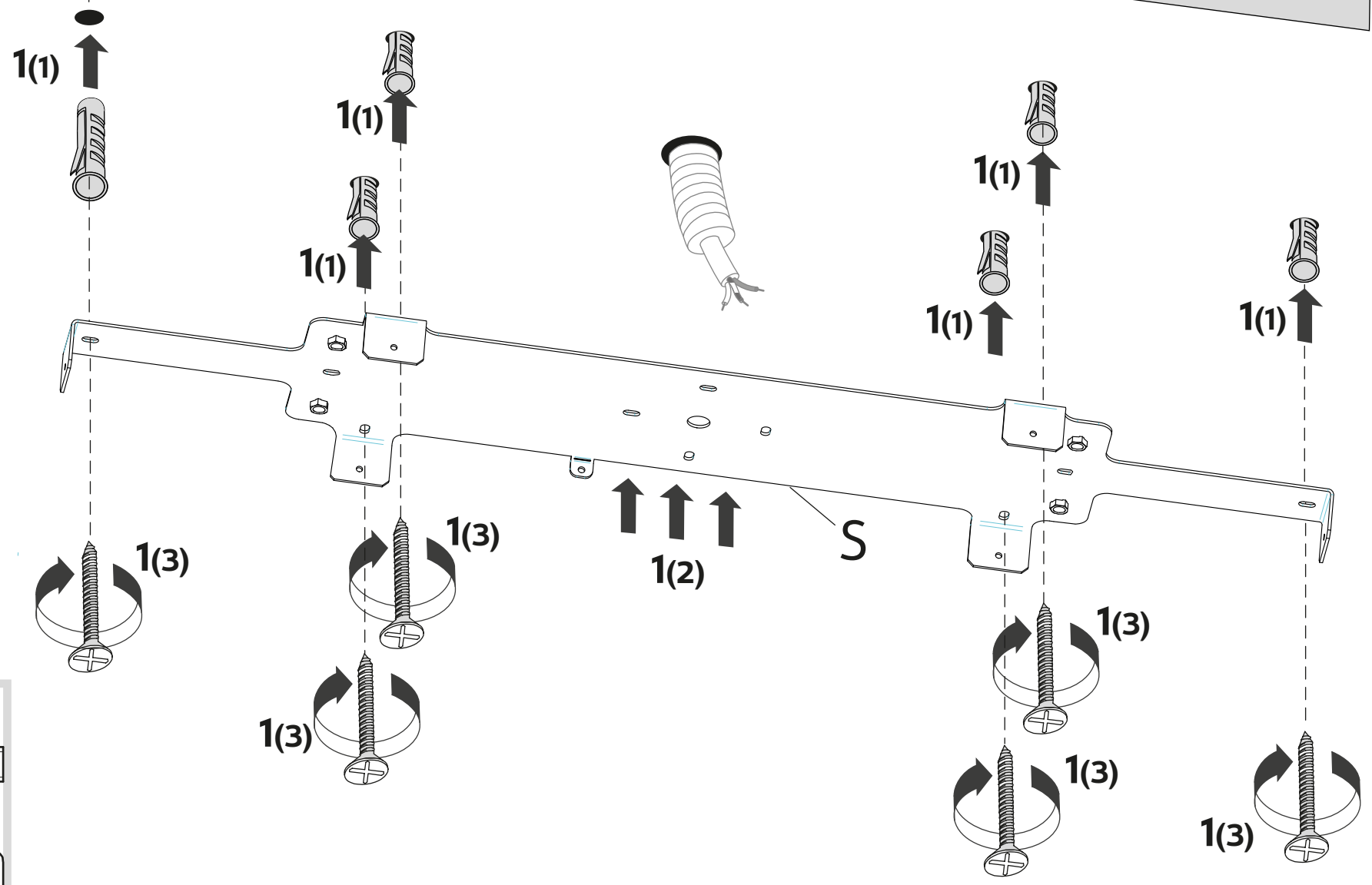
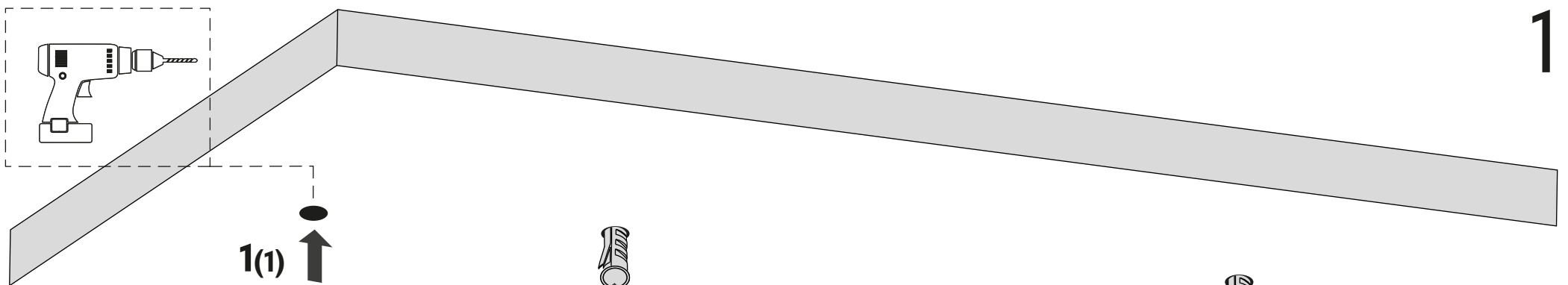

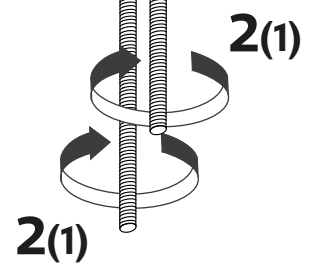
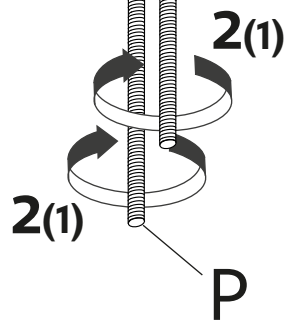
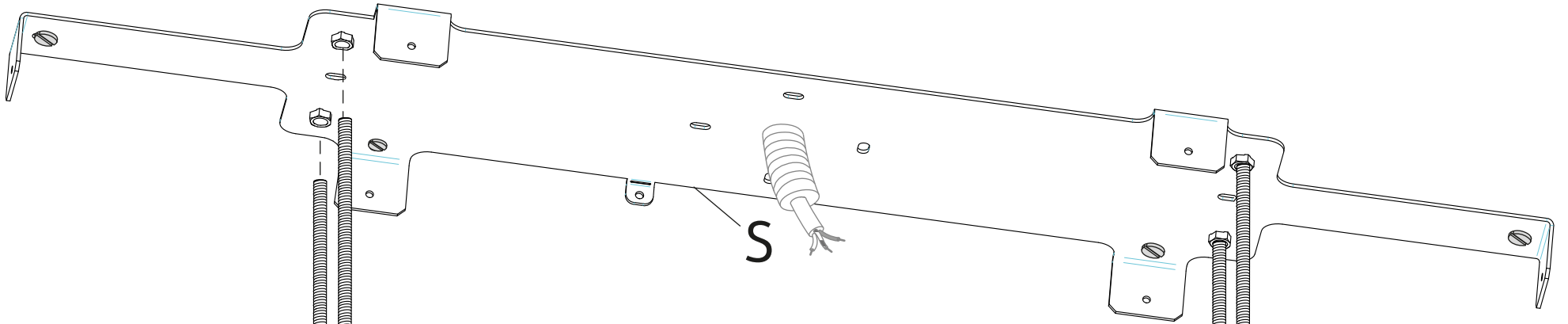
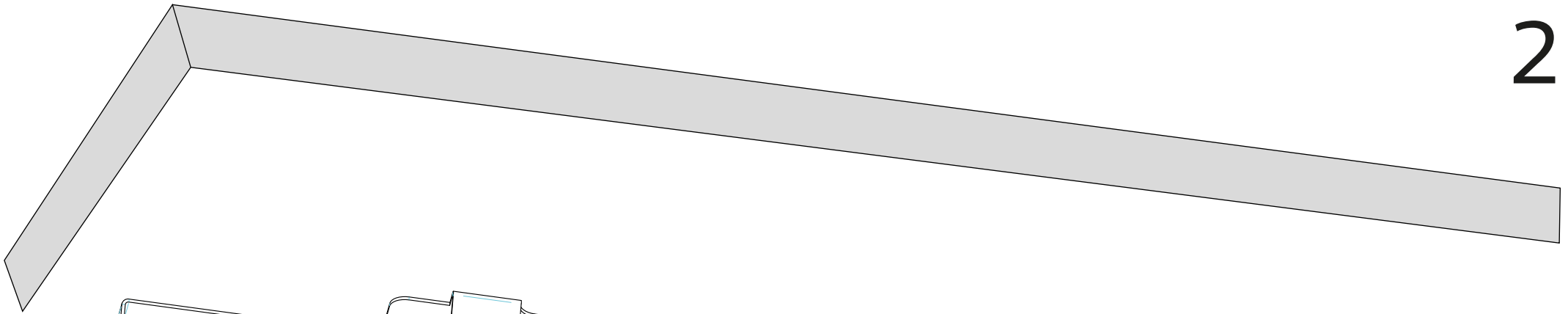

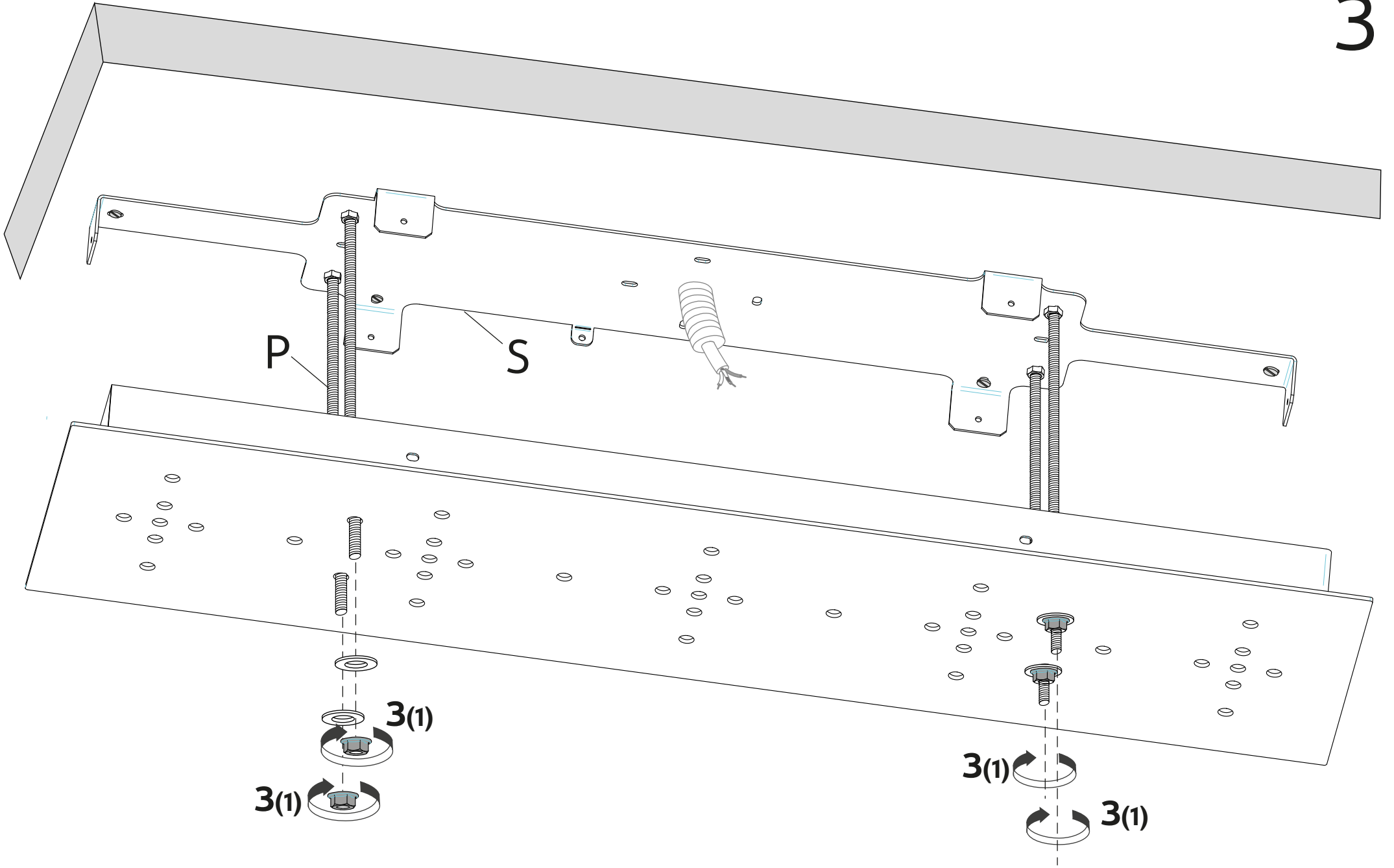

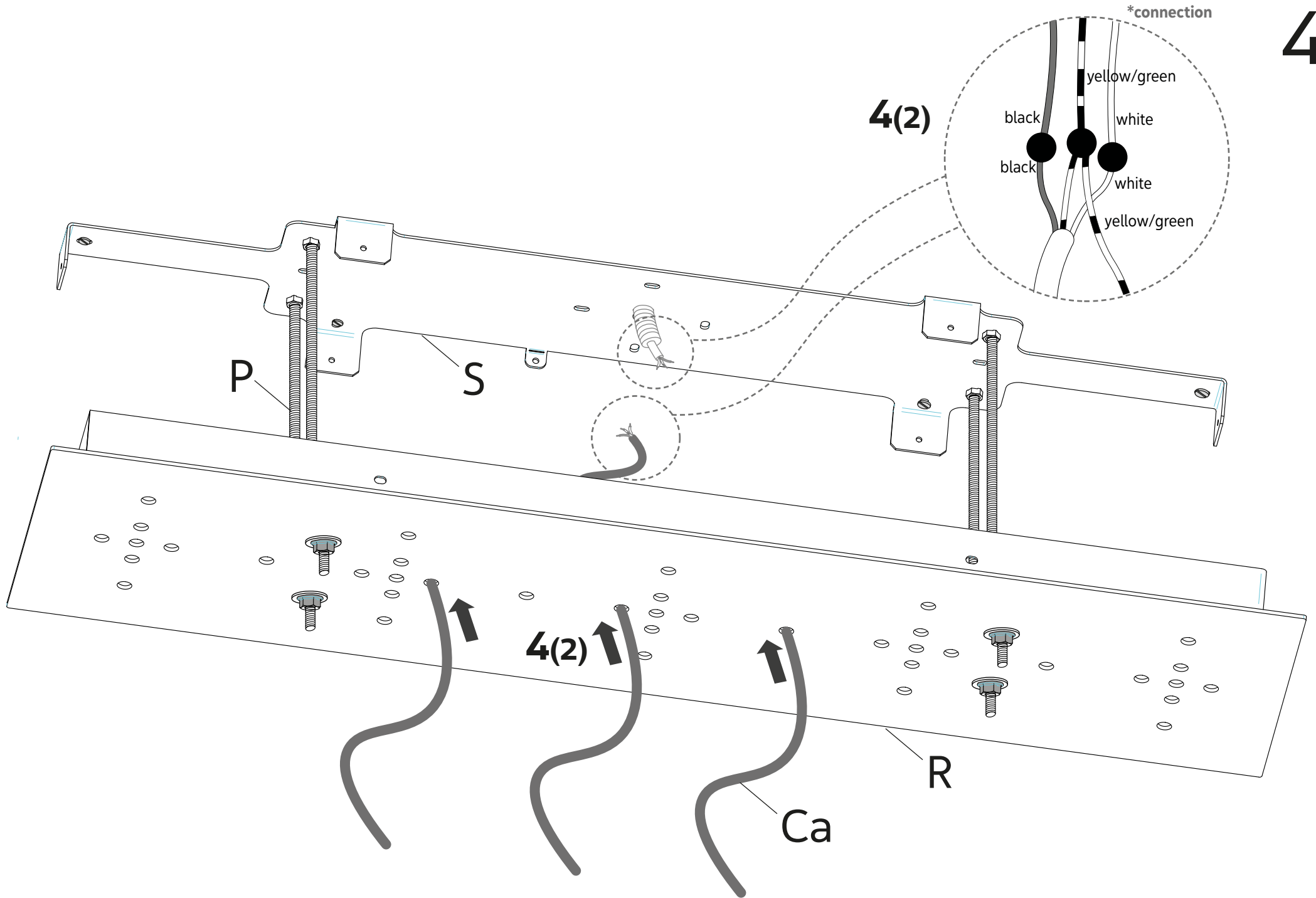

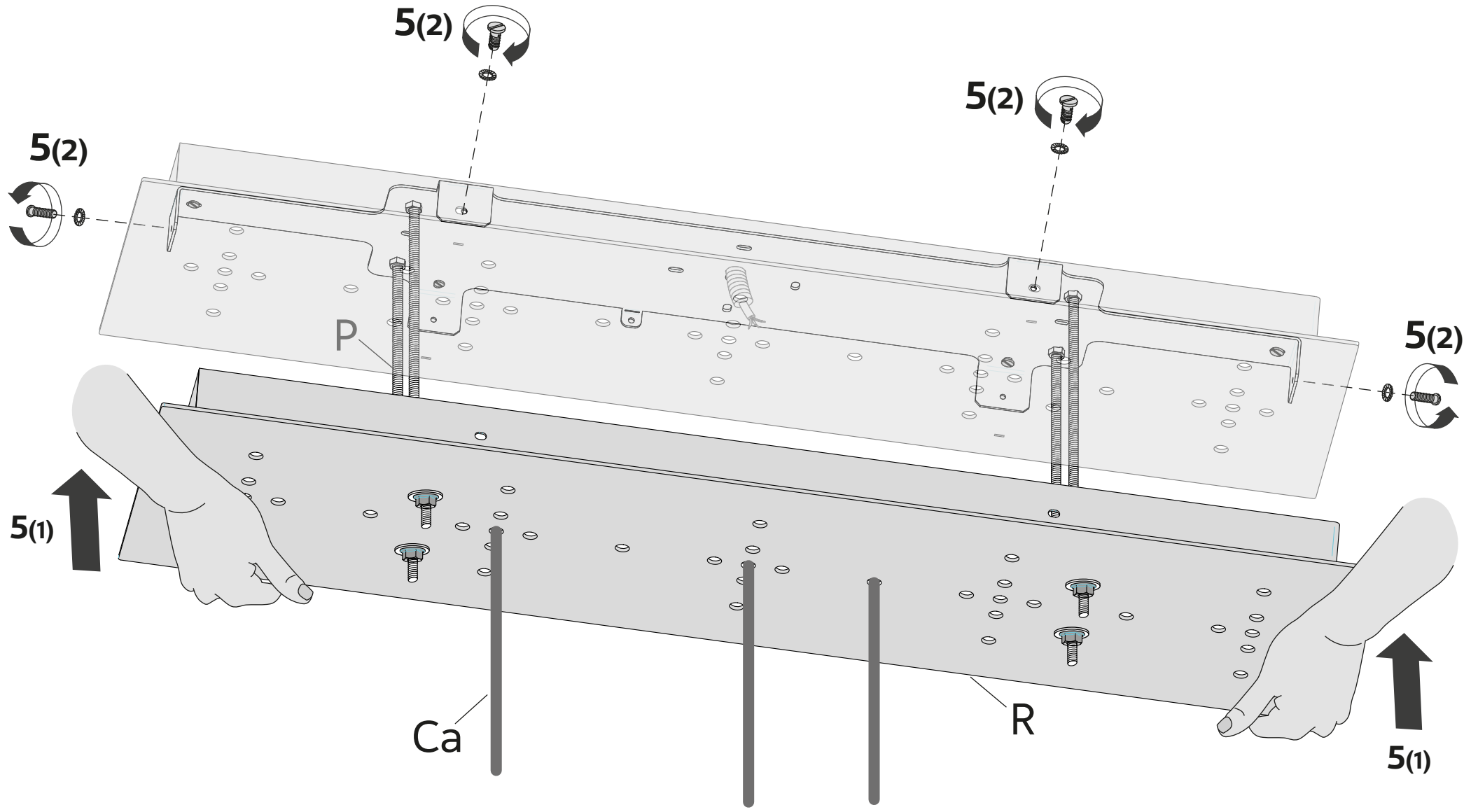

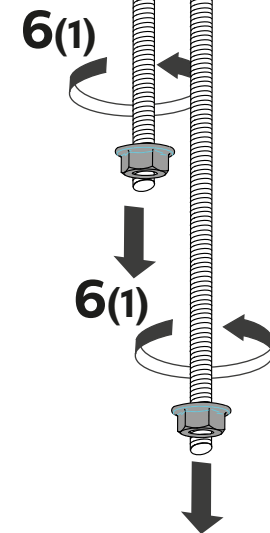
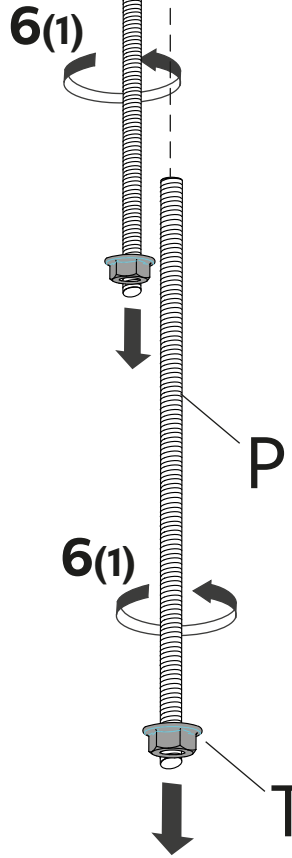
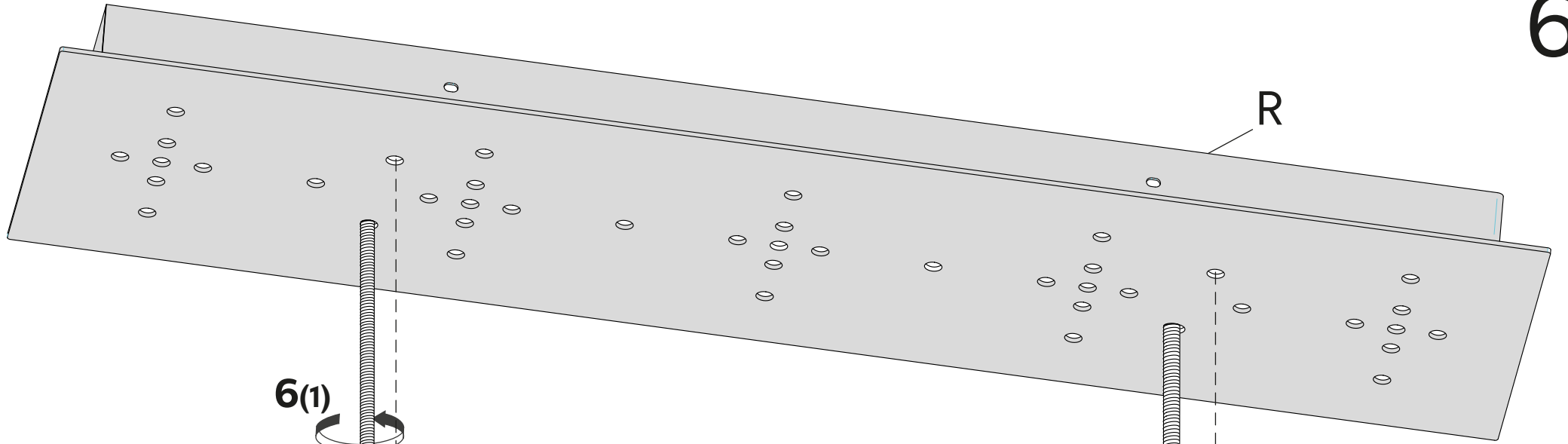

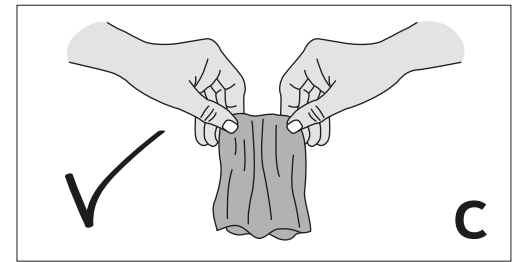
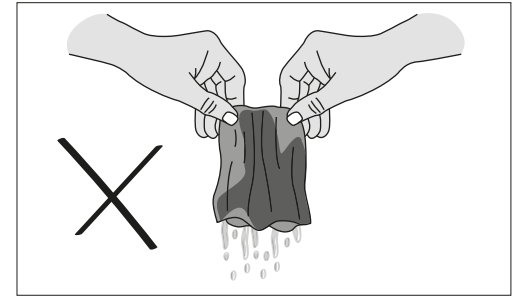
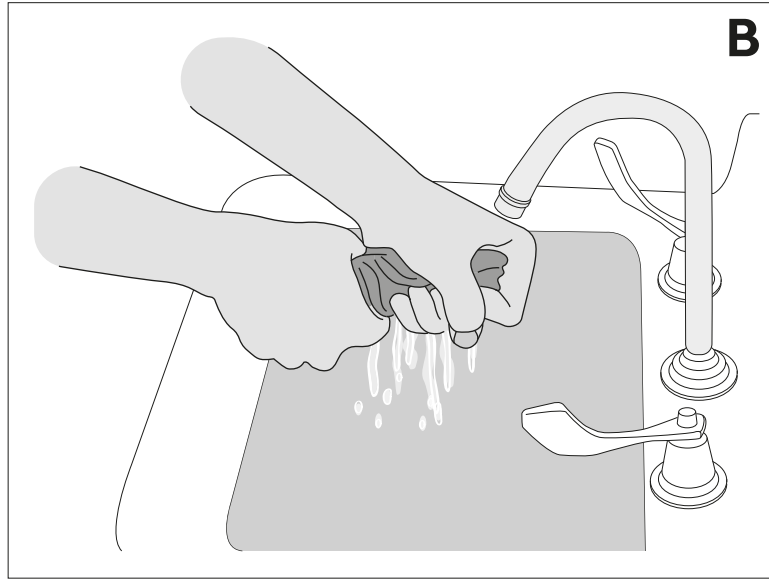

chemical agents

chemical agents

alcohol

