

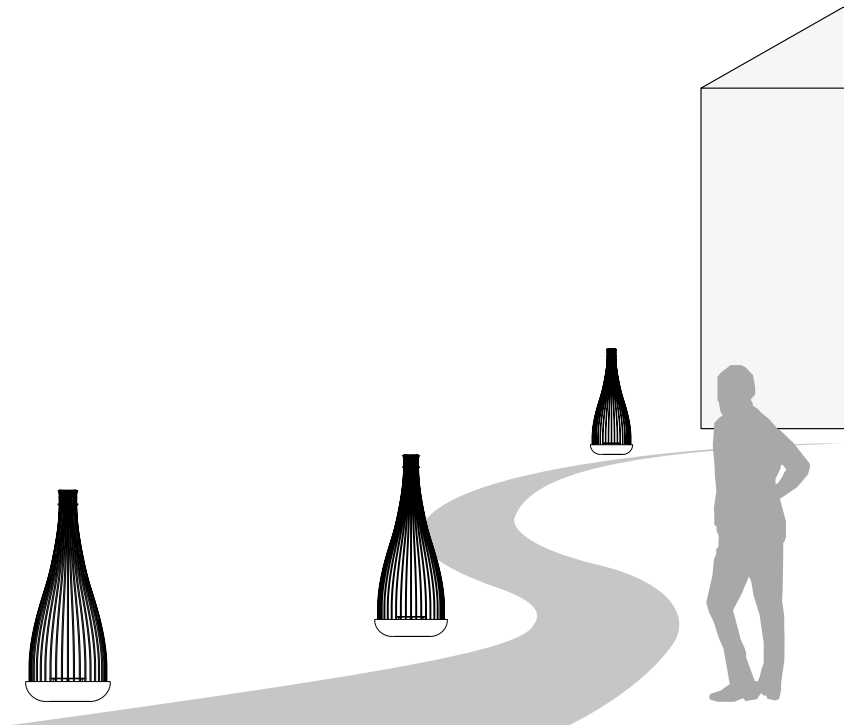

# DON'T TOUCH



**HP153 AB EXT (3000K)  
-AC153 BC EXT**

**220-240V  
LED 1x29W, 2600lumen  
3000K/2700K CRI ≥80**



**IP67**   **CE**

Karman srl

Via A. Grandi, San Martino del piano, 61034 Fossombrone (PU), Italy - p.iva 02175640412 tel +39 0721 71 5042 r.a fax +39 0721 716640 - [www.karmanitalia.it](http://www.karmanitalia.it)



# C - 01

x 120 pz

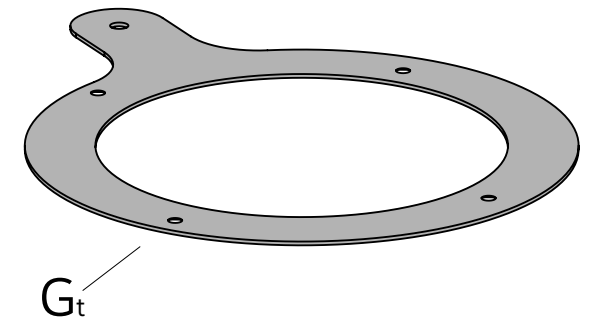
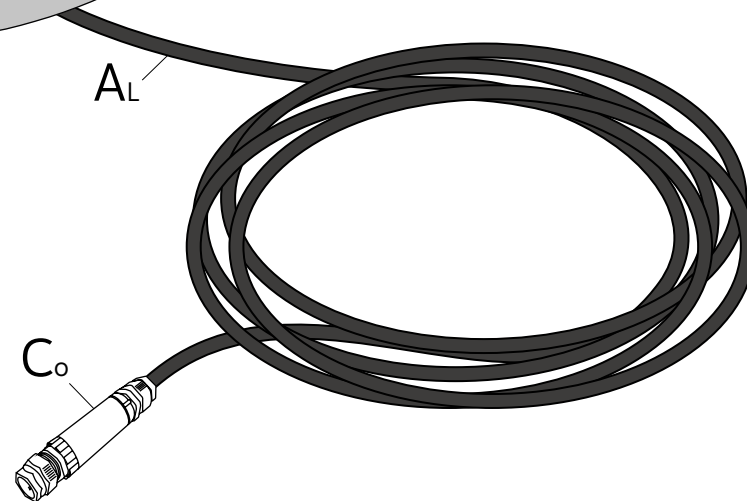
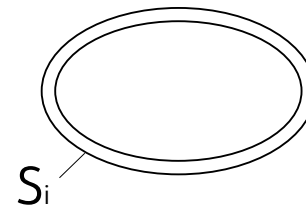
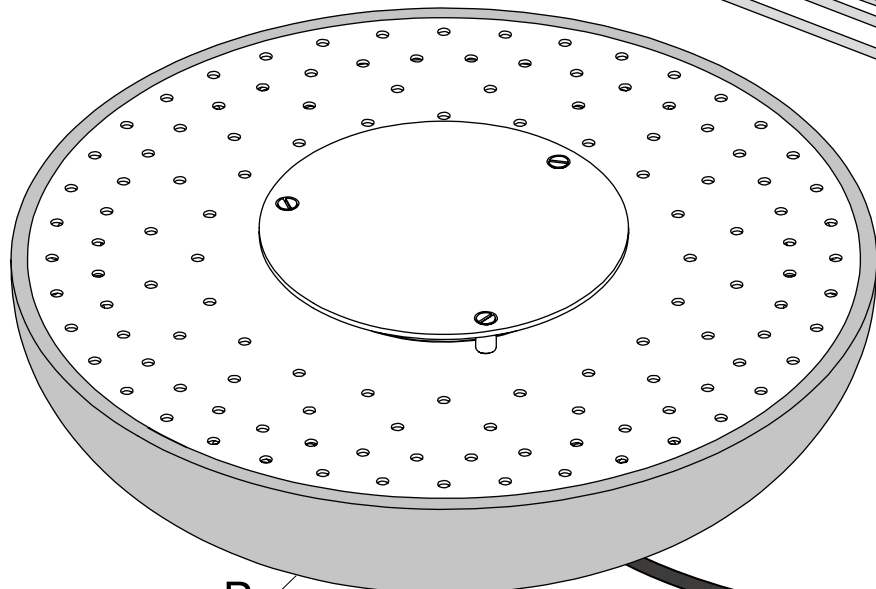
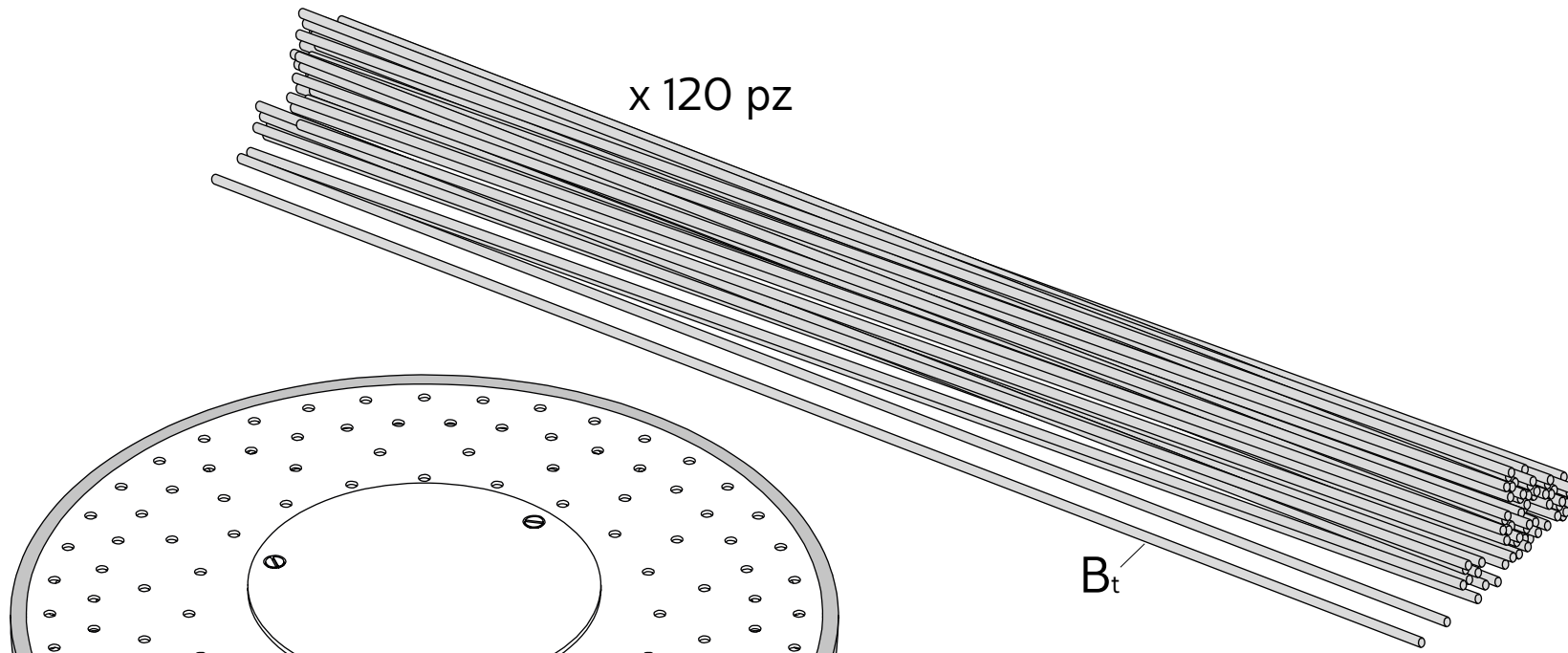
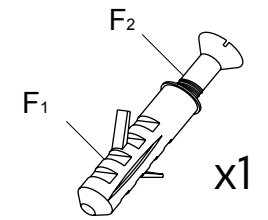
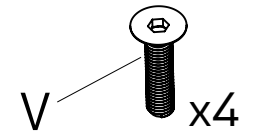

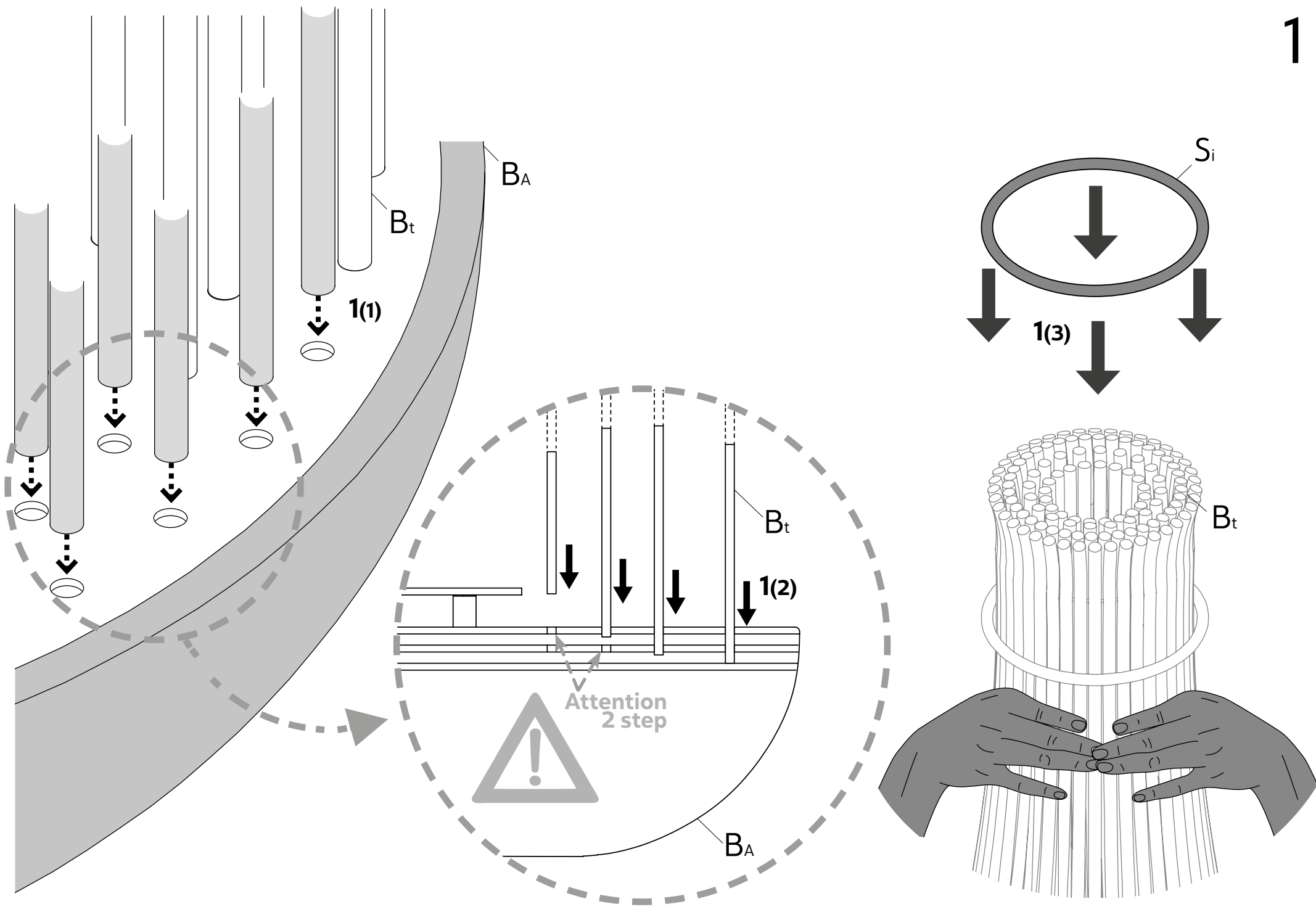

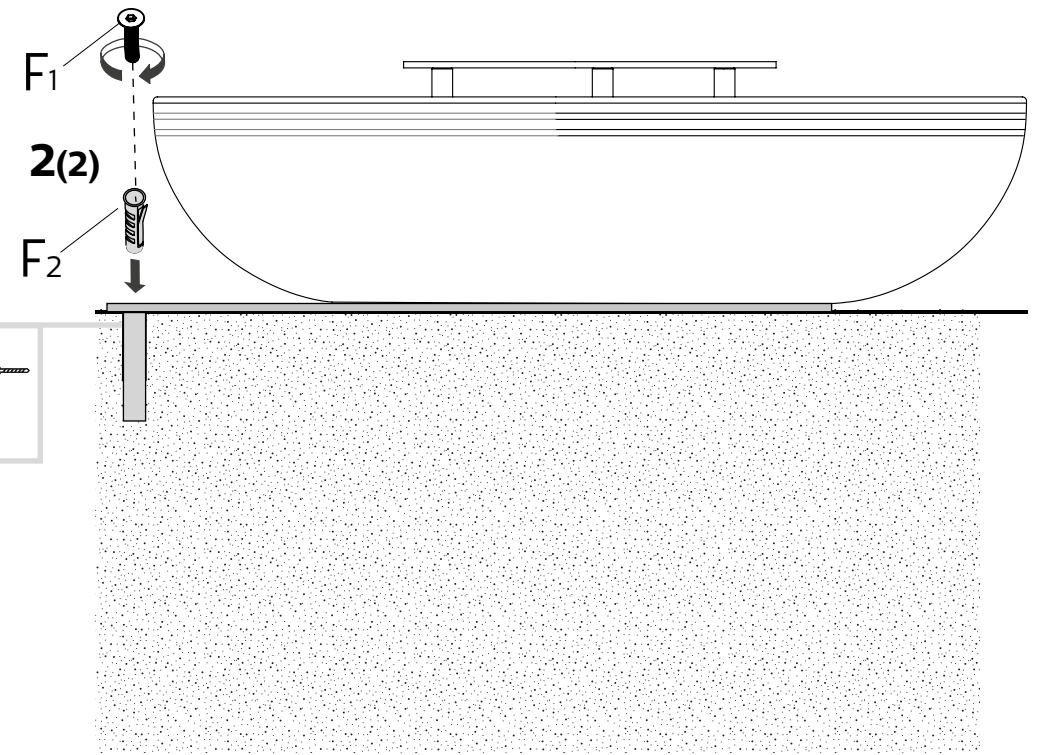
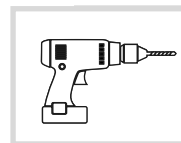
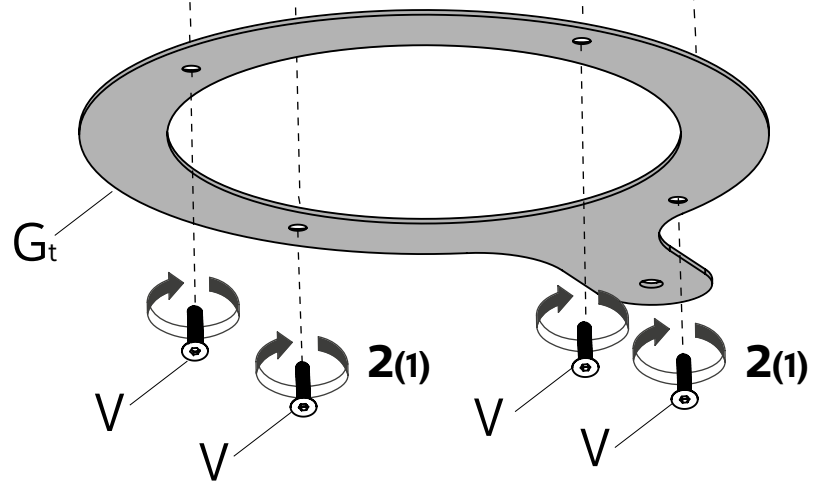
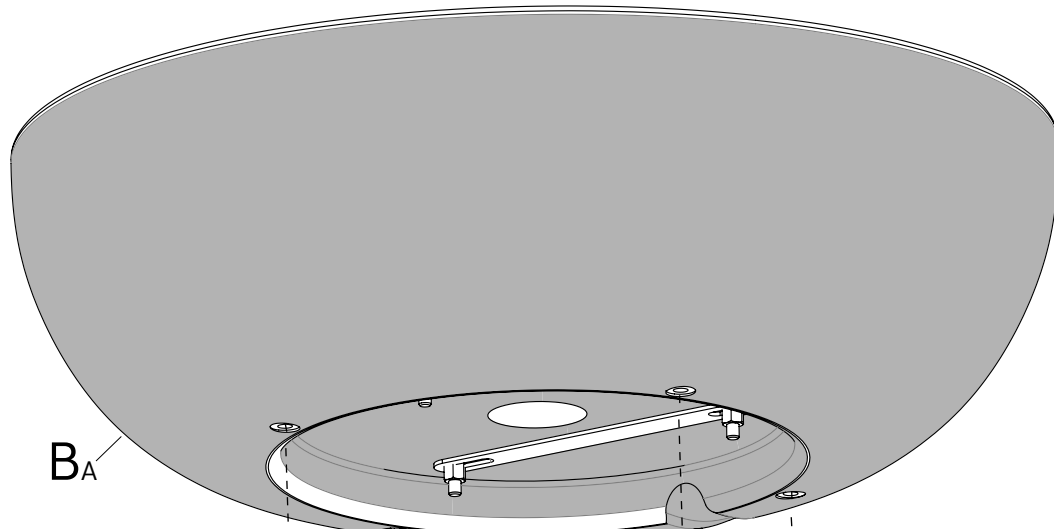

chemical agents

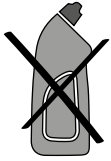

chemical agents



alcohol



**D**

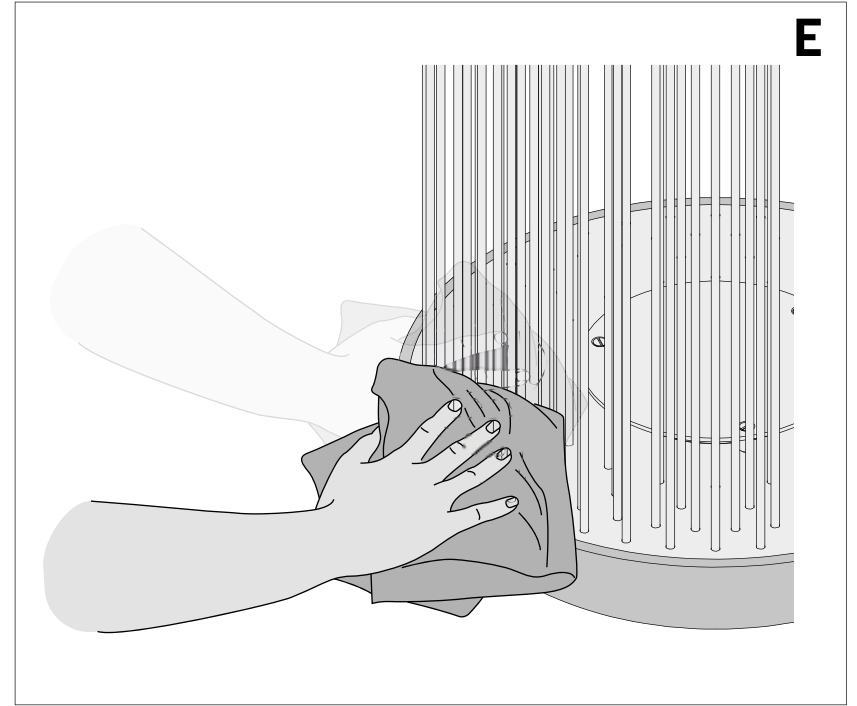

**E**



**A**

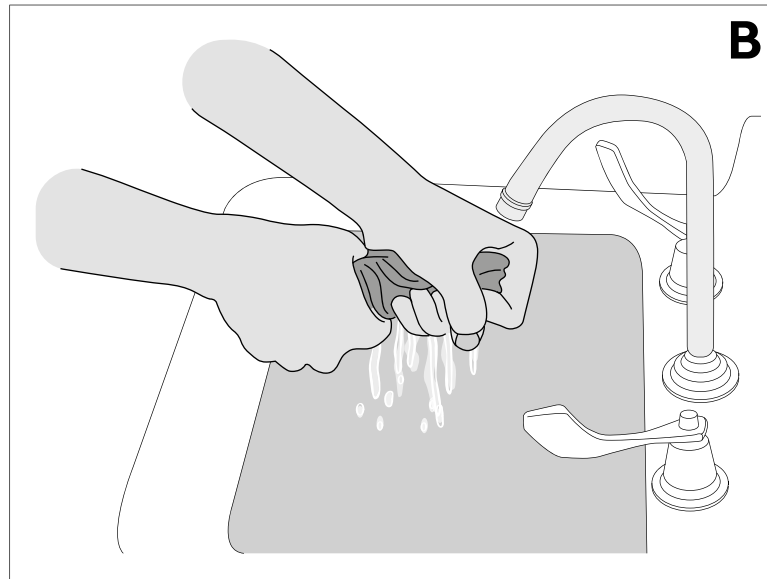

**B**

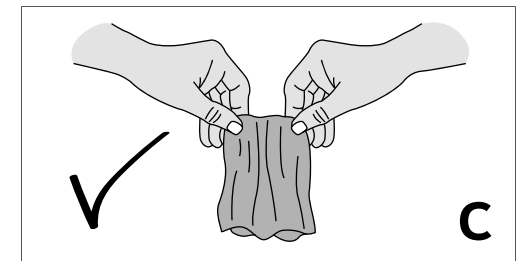
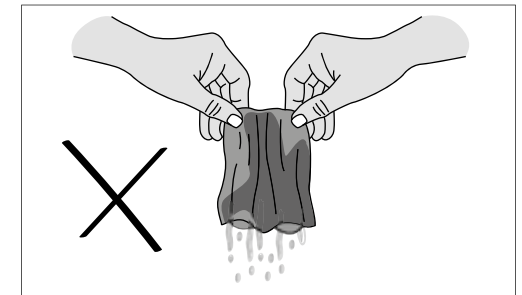

**C**